



**Applications:**

Suitable for commercial, retail and institutional applications including gymnasiums, factories and warehouses.

**Features**

- Offering quality lighting and excellent energy savings compared to linear fluorescent and HID highbay fixtures.
- Voltage is 120-277V & 347V/480V.
- Lumen output from 8800-43800lm with efficacy up to 144lm/W.
- Multiple optics Prismatic Diffuser, Medium lens and Aisle lens available.
- PIR Sensor optional and supports Emergency Battery.
- Standard 0-10V dimming Chain or pendant mounting available Projected life span of 50,000 hrs.
- Operating temperature is -40°C to 55°C (-40°F to 131°F).
- UL/cUL damp location and DLC qualified.

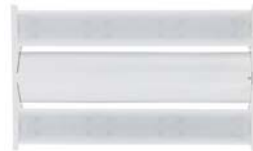

95W



190W



160W



320W



80W&105W



200W

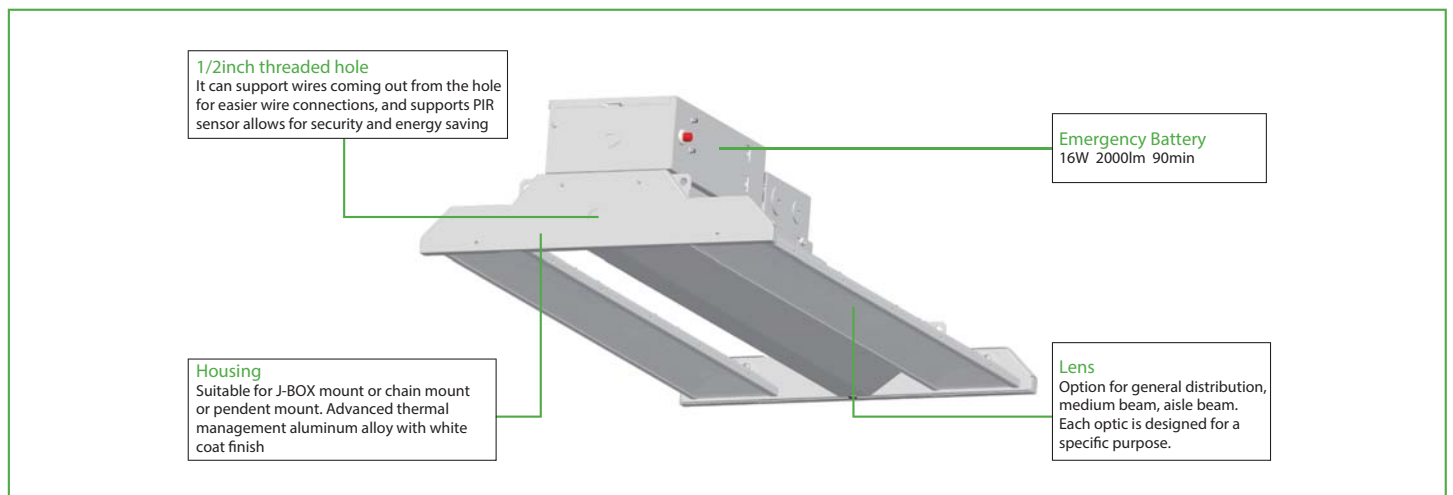

# PERFORMANCE DATA

SYSTEM WATTS	SIZE	LENS	VOLTAGE	CRI	4000K		5000K	
					LUMENS	LPW	LUMENS	LPW
80W	2x2FT	Prismatic diffuser	120-277VAC	80	8800lm	110 lm/W	8900lm	111 lm/W
		Medium Lens	120-277VAC	80	11000lm	138 lm/W	11500lm	144 lm/W
		Aisle Lens	120-277VAC	80	10500lm	131 lm/W	11000lm	138 lm/W
105W	2x2FT	Prismatic diffuser	120-277VAC	80	13000lm	124 lm/W	13200lm	126 lm/W
		Medium Lens	120-277VAC	80	13300lm	127 lm/W	13600lm	130 lm/W
		Aisle Lens	120-277VAC	80	13000lm	124 lm/W	13200lm	126 lm/W
160W	2x2FT	Prismatic diffuser	120-277VAC	80	17600lm	110 lm/W	18000lm	113 lm/W
		Medium Lens	120-277VAC	80	22000lm	138 lm/W	22200lm	139 lm/W
		Aisle Lens	120-277VAC	80	21900lm	137 lm/W	22200lm	139 lm/W
200W	2x4FT	Prismatic diffuser	120-277VAC	80	20000lm	100 lm/W	20000lm	100 lm/W
		Medium Lens	120-277VAC	80	24500lm	123 lm/W	25800lm	129 lm/W
		Aisle Lens	120-277VAC	80	24400lm	122 lm/W	24800lm	124 lm/W
320W	2x4FT	Prismatic diffuser	120-277VAC	80	35000lm	109 lm/W	36000lm	113 lm/W
		Medium Lens	120-277VAC	80	42400lm	133 lm/W	43800lm	137 lm/W
		Aisle Lens	120-277VAC	80	42400lm	133 lm/W	43800lm	137 lm/W
95W	1x2FT	Prismatic diffuser	120-277VAC	70	12350lm	130 lm/W	12350lm	130 lm/W
190W	1x4FT	Prismatic diffuser	120-277VAC	70	24700lm	130 lm/W	24700lm	130 lm/W

# ELECTRICAL DATA

Number Of Drivers	Driver Current (mA)	Nominal Power (W)	INPUT VOLTAGE (V)	CURRENT (Amps)
1	2120	80	120	0.67
		80	208	0.38
		80	240	0.33
		80	277	0.29
		90	347	0.26
		90	480	0.19
1	2500	95	120	0.79
		95	208	0.46
		95	240	0.40
		95	277	0.34
1	2600	105	120	0.88
		105	208	0.50
		105	240	0.44
		105	277	0.38
		110	347	0.32
		110	480	0.23
2	4240	160	120	1.33
		160	208	0.77
		160	240	0.67
		160	277	0.58
		170	347	0.49
		170	480	0.35
2	5000	190	120	1.58
		190	208	0.91
		190	240	0.79
		190	277	0.69
2	5140	200	120	1.67
		200	208	0.96
		200	240	0.83
		200	277	0.72
		220	347	0.63
		220	480	0.46
4	8480	320	120	2.67
		320	208	1.54
		320	240	1.33
		320	277	1.16
		350	347	1.01
		350	480	0.73

# DIMENSION

unit: inch/mm

## 2x2'

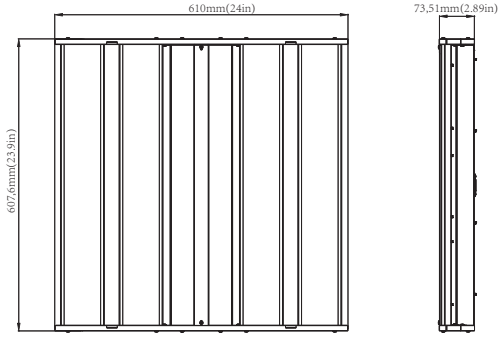

Weight: 80W&105W: 11.13lb  
160W: 15.08lb

## 2x4'

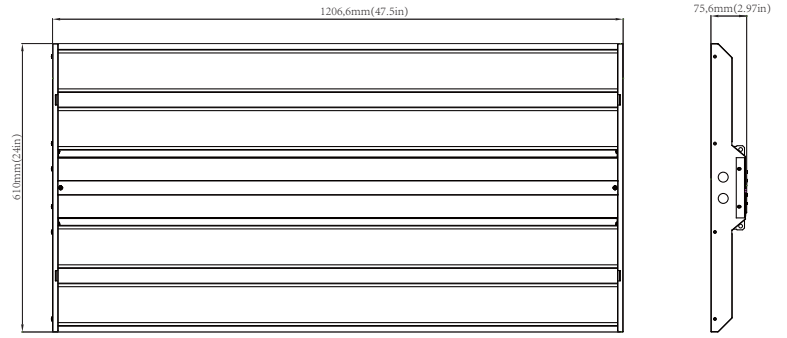

Weight: 200W: 19.07lb  
320W: 26.12lb

## 1x2'

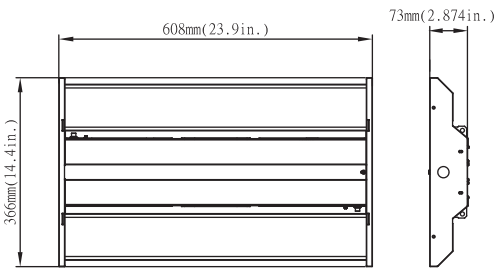

Weight: 95W: 9.05lb

## 1x4'

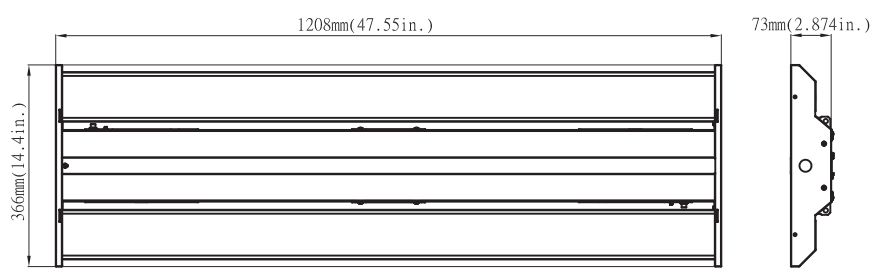

Weight: 190W: 16.51lb

# PHOTOMETRICS

### General

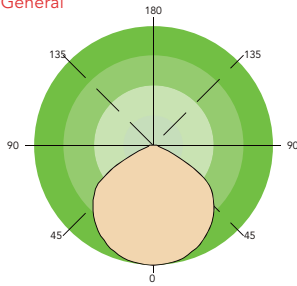

### Aisle

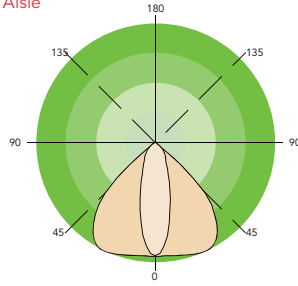

### Medium

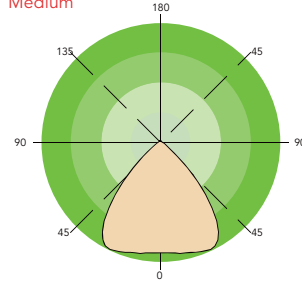

# ORDERING GUIDE

Example: II-HBL22D80W27V40KHMPDB

Fixture Type	Size	Power Consumption		Input Voltage	CCT	CRI	Sensor (Option)	Diffuser (Option)	Backup Battery(Option)
		80W	90W						
II-HBL Linear High Bay	22D 2FT*2FT	80	90	27V 120-277V 48V 347V/480V	40K 4000K 50K 5000K	B ≥ 70 H ≥ 80	M Motion Sensor Blank Without Sensor	AL Aisle Lens MD Medium Lens PD Prismatic Diffuser CD Clear Diffuser Blank Without lens	B Emergency Battery Blank Without Emergency Battery
	24D 2FT*4FT	105	110						
	12D 1FT*2FT	160	170						
	14D 1FT*4FT	200	220						
		320	350						
		95	190						

Note: 1. External Motion Sensor, optional for on/off type and bi-level type.  
2. 90W, 110W, 170W, 220W and 350W are limited to 347V or 480V input only.

# DLC Model NO.

SYSTEM WATTS	VOLTAGE	CCT	LENS	DLC NO.	DLC Classification
80W	120-277V	4000K	Prismatic Diffuser	HBL22D80W27V40KH[BLANK M]PD[BLANK B]	Standard
	120-277V	5000K	Prismatic Diffuser	HBL22D80W27V50KH[BLANK M]PD[BLANK B]	Standard
	120-277V	4000K	Mideum Lens	HBL22D80W27V40KH[BLANK M]MD[BLANK B]	Standard
	120-277V	5000K	Mideum Lens	HBL22D80W27V50KH[BLANK M]MD[BLANK B]	Standard
	120-277V	4000K	Aisle Lens	HBL22D80W27V40KH[BLANK M]AL[BLANK B]	Standard
90W	120-277V	5000K	Aisle Lens	HBL22D80W27V50KH[BLANK M]AL[BLANK B]	Standard
	347/480V	4000K	Mideum Lens	HBL22D90W48V40KHYPDY	Standard
95W	347/480V	5000K	Mideum Lens	HBL22D90W48V50KHYPDY	Standard
	120-277V	4000K	Prismatic Diffuser	HBL12D95W27V40KB[Blank;M]PD[Blank;B]	Premium
95W	120-277V	5000K	Prismatic Diffuser	HBL12D95W27V50KB[Blank;M]PD[Blank;B]	Premium
	120-277V	4000K	Mideum Lens	HBL12D95W27V40KB[Blank;M]MD[Blank;B]	Premium
	120-277V	5000K	Mideum Lens	HBL12D95W27V50KB[Blank;M]MD[Blank;B]	Premium
	120-277V	4000K	Mideum Lens	HBL12D95W27V40KH[Blank;M]MD[Blank;B]	Premium
105W	120-277V	4000K	Prismatic Diffuser	HBL22D105W27V40KH[BLANK M]PD[BLANK B]	Standard
	120-277V	5000K	Prismatic Diffuser	HBL22D105W27V50KH[BLANK M]PD[BLANK B]	Standard
	120-277V	4000K	Mideum Lens	HBL22D105W27V40KH[BLANK M]MD[BLANK B]	Standard
	120-277V	5000K	Mideum Lens	HBL22D105W27V50KH[BLANK M]MD[BLANK B]	Standard
	120-277V	4000K	Aisle Lens	HBL22D105W27V40KH[BLANK M]AL[BLANK B]	Standard
	120-277V	5000K	Aisle Lens	HBL22D105W27V50KH[BLANK M]AL[BLANK B]	Standard
	120-277V	4000K	Blank	HBL22D105W27V40KH[Blank;M][Blank;B]	Standard
	120-277V	5000K	Blank	HBL22D105W27V50KH[Blank;M][Blank;B]	Standard
110W	347/480V	4000K	Prismatic Diffuser	HBL22D110W48V40KHYPDY	Standard
	347/480V	5000K	Prismatic Diffuser	HBL22D110W48V50KHYPDY	Standard
	347/480V	4000K	Mideum Lens	HBL22D110W48V40KHYPDY	Standard
	347/480V	5000K	Mideum Lens	HBL22D110W48V50KHYPDY	Standard
160W	120-277V	4000K	Prismatic Diffuser	HBL22D160W27V40KH[BLANK M]PD[BLANK B]	Standard
	120-277V	5000K	Prismatic Diffuser	HBL22D160W27V50KH[BLANK M]PD[BLANK B]	Standard
	120-277V	4000K	Mideum Lens	HBL22D160W27V40KH[BLANK M]MD[BLANK B]	Standard
	120-277V	5000K	Mideum Lens	HBL22D160W27V50KH[BLANK M]MD[BLANK B]	Standard
	120-277V	4000K	Aisle Lens	HBL22D160W27V40KH[BLANK M]AL[BLANK B]	Standard
	120-277V	5000K	Aisle Lens	HBL22D160W27V50KH[BLANK M]AL[BLANK B]	Standard
170W	347/480V	4000K	Prismatic Diffuser	HBL22D170W48V40KHYPDY	Standard
	347/480V	5000K	Prismatic Diffuser	HBL22D170W48V50KHYPDY	Standard
	347/480V	4000K	Mideum Lens	HBL22D170W48V40KHYPDY	Standard
	347/480V	5000K	Mideum Lens	HBL22D170W48V50KHYPDY	Standard
190W	120-277V	4000K	Prismatic Diffuser	HBL14D190W27V40KB[Blank;M]PD[Blank;B]	Premium
	120-277V	5000K	Prismatic Diffuser	HBL14D190W27V50KB[Blank;M]PD[Blank;B]	Premium
	120-277V	4000K	Mideum Lens	HBL14D190W27V40KB[Blank;M]MD[Blank;B]	Premium
	120-277V	5000K	Mideum Lens	HBL14D190W27V50KB[Blank;M]MD[Blank;B]	Premium
200W	120-277V	4000K	Mideum Lens	HBL24D200W27V40KH[BLANK M]MD[BLANK B]	Standard
	120-277V	5000K	Mideum Lens	HBL24D200W27V50KH[BLANK M]MD[BLANK B]	Standard
	120-277V	4000K	Aisle Lens	HBL24D200W27V40KH[BLANK M]AL[BLANK B]	Standard
	120-277V	5000K	Aisle Lens	HBL24D200W27V50KH[BLANK M]AL[BLANK B]	Standard
	120-277V	4000K	Blank	HBL24D200W27V40KH[Blank;M][Blank;B]	Standard
	120-277V	5000K	Blank	HBL24D200W27V50KH[Blank;M][Blank;B]	Standard
220W	347/480V	4000K	Mideum Lens	HBL24D220W48V40KHYPDY	Standard
	347/480V	5000K	Mideum Lens	HBL24D220W48V50KHYPDY	Standard
320W	120-277V	4000K	Prismatic Diffuser	HBL24D320W27V40KH[BLANK M]PD[BLANK B]	Standard
	120-277V	5000K	Prismatic Diffuser	HBL24D320W27V50KH[BLANK M]PD[BLANK B]	Standard
	120-277V	4000K	Mideum Lens	HBL24D320W27V40KH[BLANK M]MD[BLANK B]	Standard
	120-277V	5000K	Mideum Lens	HBL24D320W27V50KH[BLANK M]MD[BLANK B]	Standard
	120-277V	4000K	Aisle Lens	HBL24D320W27V40KH[BLANK M]AL[BLANK B]	Standard
	120-277V	5000K	Aisle Lens	HBL24D320W27V50KH[BLANK M]AL[BLANK B]	Standard
	120-277V	4000K	Blank	HBL24D320W27V40KH[Blank;M][Blank;B]	Standard
	120-277V	5000K	Blank	HBL24D320W27V50KH[Blank;M][Blank;B]	Standard
350W	347/480V	4000K	Prismatic Diffuser	HBL24D350W48V40KHYPDY	Standard
	347/480V	5000K	Prismatic Diffuser	HBL24D350W48V50KHYPDY	Standard
	347/480V	4000K	Mideum Lens	HBL24D350W48V40KHYPDY	Standard
	347/480V	5000K	Mideum Lens	HBL24D350W48V50KHYPDY	Standard