

DESCRIPTION

The popular wall pack is now available with long-lasting, energy-efficient LED technology. Featuring a classic day form, wall pack LED offers a traditional appearance and is powered by advanced LEDs. Wall pack LED luminaire is powerful yet energy efficient, capable of replacing up to a 320W metal halide luminaire while saving up to 80% in energy costs.

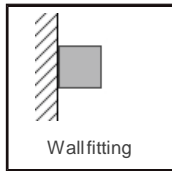

--	--	--	--	--	--	--	--

ORDERING INFORMATION

Model	Watts	Lumen	Optic	Color Temp.	CRI	Optional	Finish color
LI-WMG080-AA	80	7680	A= 180	1 = 4000K 2 = 5000K	80	1 = Dimmable	BR

Ordering Example:
LI-WMG080-AA-80-A-1-1-BR

Project name:



- Material: Rugged one-piece die-cast aluminum housing and hinged, removable die-cast aluminum door. One-piece silicone gasket seals the optical chamber. High efficient reflector and Polycarbonate optical lens with UV stabilizers diffuser. Finished in five-stage super TGIC polyester powder coat paint, 2.5 mil nominal thickness for superior protection against fade and wear. Standard color is bronze.
- Led type: Philips chips.
- Electrical: 120~ 277Vac, 50/60Hz Driver included.
- Power factor: $\geq 90\%$
- Led efficiency: 105 lm/W
- Color temperature: 4000K, 5000K
- Operation temperature: -40°C to 40°C
- Color Rendering Index (CRI): ≥ 80
- THD%: $< 20\%$
- IP Rating: IP65

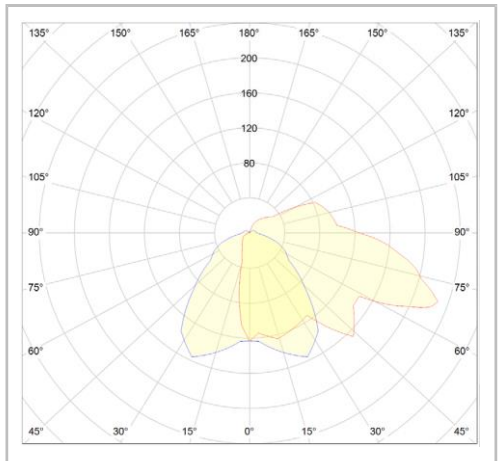
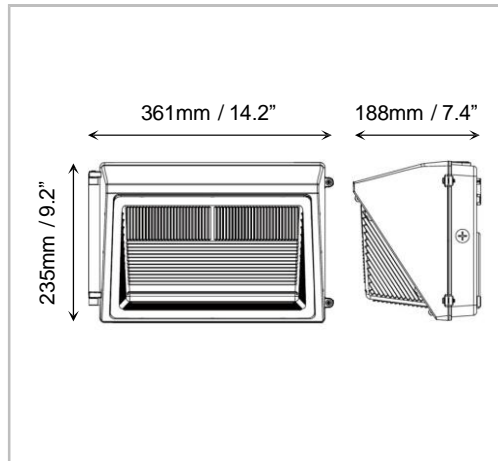

Project name:

