

DESCRIPTION

RAY Series is a LED flood light with elegant design which enhances aesthetic value while is providing energy efficient lighting.

RAY series operate on the line voltage that eliminate the need of outdoor driver.

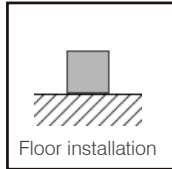
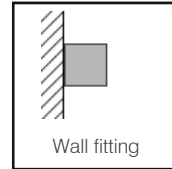

--	--	--	--	--	--	--	--

ORDERING INFORMATION

Model	Watts	Lumen	Optic	Color Temp.	CRI	Optional	Finish color
LI-FLDG015-YZ	15	1620	A = 35 B = 60	1 = 3000K 2 = 5000K	82	1 = Dimmable	BR

Ordering Example:
LI-FLDG015-YZ-YK-15-A-1-1-BR

Project name:



- Material: Die-cast Aluminum housing. Superior. Architectural Powder Coat Finish. Fluted Reflector & Tempered Glass Lens. Aluminum LED Board - High Conductive. Waterproof, Aging Resistance, Salt Mist Resistance.
- Led type: Philips Lumiled LUXEON 3030 2D.
- Electrical: 120~ 277Vac, 50/60Hz Driver included.
- Power factor: $\geq 90\%$
- Led efficiency: 130 lm/W
- Color temperature: 3000K, 5000K
- Operation temperature: -40°C to 55°C
- Color Rendering Index (CRI): ≥ 82
- THD%: $< 20\%$
- IP Rating: IP65

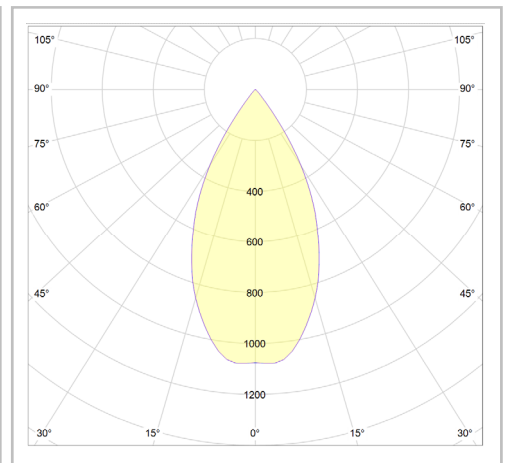
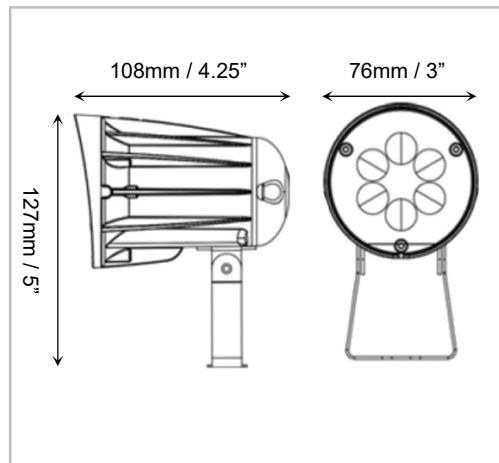

Project name:

